

Evoca **EV7** In-ground
Installation Instructions



Warranty Void if not installed as per installation instructions and in compliance with the local electrical code.

READ ALL SAFETY INSTRUCTIONS FIRST

- › Follow instructions carefully, failure to do so will void warranty.
- › Ensure installation complies with local law and applicable standards.
- › Input voltage range:
24 V DC (International market)
12-15V, 60Hz or 12-24V DC (North American market)
- › Only use Lumascape power supplies.
- › Fixture uses an intelligent driver. Always leave on for 20 seconds unless programming.
- › All connections must be kept dry; failure to do so may result in product reliability issues.
- › Use of an electronic transformer will permanently damage the luminaire.
- › Do not make modifications to or alter the product.
- › Never make connections whilst the power is connected.
- › Opening luminaire will void warranty.

Component Overview

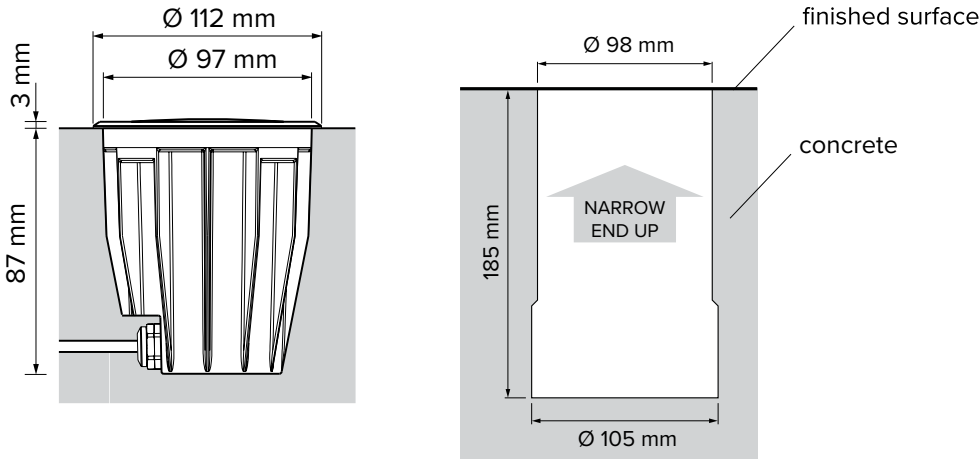

LS6137 Pre-Install Sleeve (order separately.)

DANGER

ISOLATE LUMINAIRE FROM POWER

Failure to isolate power supply before installation or maintenance may result in fire, serious injury, electric shock, death and may damage the luminaire.

Wiring Polarity



Ensure installation complies with local laws and applicable standards.

Colour Changing Integral Driver

Wire Colour	Designation
White	+
Black	-
Orange	PWM Common
Red	PWM Red
Green	PWM Green
Blue	PWM Blue

Static Colour Dimming

Wire Colour	Designation
Red	+
Black	-
Orange*	PWM +
Grey*	PWM -

Static Colour Non-Dimming

Wire Colour	Designation
White	+
Black	-

IMPORTANT:

Please note that the PWM dimming signal polarity is reversed with Lumascape's LS6125 and any third party PWM controllers.

Products and specifications are subject to change without notice.

Installation – Direct Burial

WARNING

- › Luminaires can become very hot. Use discretion in placement.
- › Keep electronics free from dirt and moisture.
- › No power tools to be used.
- › Do not shorten, interfere or disconnect cable from luminaire.
- › Warranty will be void if cable assembly is tampered with.
- › Not suitable for drive-over applications.

Power supply must be isolated prior to connection or disconnection of cables. Failure to do so will result in damage to luminaire components.

Step 1

Use a Lumascape supplied 24V DC ripple-free power supply to locate centrally in relation to the luminaires.

Mark actual locations of luminaires to be installed. Calculate the distances, wire gauge and power supply sizes.

NOTE: If dimming is required, four (4) wires must be run. For RGB installations, six (6) supply wires must be run to the luminaire. Refer to the Wiring Polarity table for dimming and number of wires required.

Step 2

Cast or core drill void to accommodate the fitting as shown. Ensure a neat hole is achieved. Ensure gravel or similar material forms the bottom of the cavity to allow for height adjustment.

NOTE: Ensure that suitable connection access is available. Three (3) meters of round luminaire cable with 5-10mm diameter is supplied. Flexible electrical conduit is recommended.

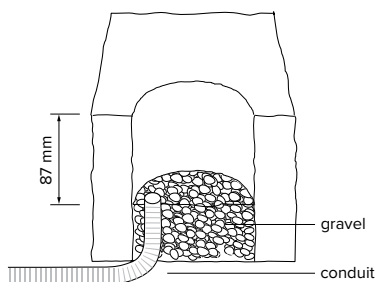

Step 3

Feed cable from luminaire into the conduit and back to the supply location. Place the luminaire on the gravel bed and adjust to the required height.

IMPORTANT: For angled lamp options: aim the luminaire at the desired object. Position correctly before fully grouting or concreting – the grout or concrete provides heat sinking.

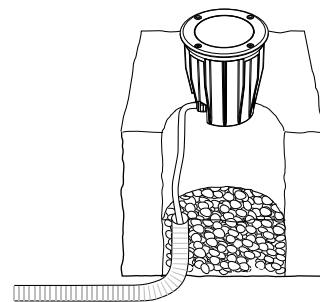

Step 4

Ensure underside of the luminaire lid is flush with the finished surface. Pour concrete or grout in place. Check that the underside of luminaire is flush with finished surface.

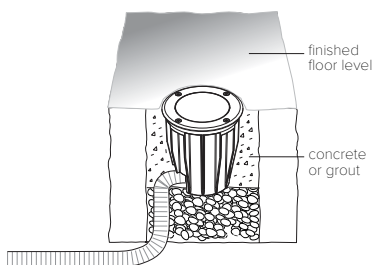

NOTE: Generally 24 V DC ripple-free power supplies should be installed in a well-ventilated, fully undercover environment. DC power supplies are more efficient than AC transformers. Under no circumstances can an 'electronic' transformer be used as this may damage the product.

Products and specifications are subject to change without notice.

Pre-Installation Sleeve

Power supply must be isolated prior to connection or disconnection of cables. Failure to do so will result in damage to luminaire components.

Step 1

Use a Lumascape supplied 24V DC ripple-free power supply to locate centrally in relation to the luminaires.

Mark actual locations of luminaires to be installed. Calculate the distances, wire gauge and power supply sizes.

NOTE: If dimming is required, four (4) wires must be run. For RGB installations, six (6) supply wires must be run to the luminaire. Refer to the Wiring Polarity table for dimming and number of wires required.

Step 2

Cast or core drill void to accommodate the sleeve. Luminaire cavity should be as shown. Ensure gravel or similar medium forms the bottom of cavity to allow drainage.

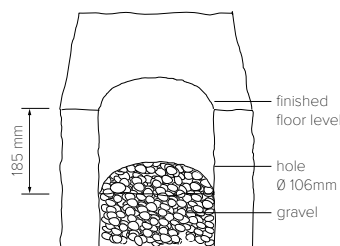

Step 3

To ensure concrete doesn't enter the luminaire cavity, place foam plug at the base of the cavity and fit sleeve over the plug.

NOTE: Ensure the narrow end of the pre-install sleeve is pointing towards the top and sits flush with the finished surface.

Step 4

Pour concrete. Check that the top surface of mounting sleeve is flush with the finished surface.

When ready to install the luminaire, destroy the foam plug and remove. Plug must be removed to allow drainage.

Connect luminaire in accordance with local wiring rules and test functionality before inserting into pre-installation sleeve.

NOTE: For angled lamp options, aim the luminaire at the desired object. Position correctly before inserting luminaire into pre-installation sleeve.

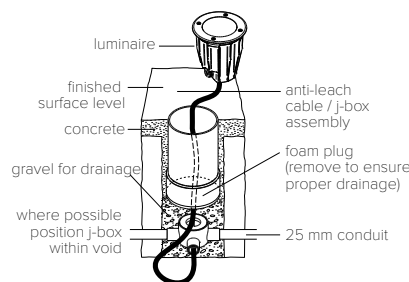
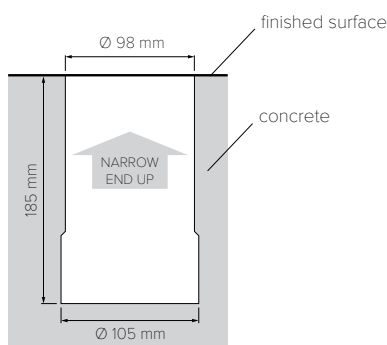

NOTE: Generally 24 V DC ripple-free power supplies should be installed in a well-ventilated, fully undercover environment. DC power supplies are more efficient than AC transformers. Under no circumstances can an 'electronic' transformer be used as this may damage the product.

Products and specifications are subject to change without notice.

ASIA PACIFIC

Brisbane Technology Park
18 Brandl Street, Eight Mile Plains
Queensland, 4113, Australia
P: +61 7 3854 5000
F: +61 7 3854 5001
E: sales@lumascape.com

CHINA

20 West Building 377 Wuyi Road
Wujin Hi-Tech Zone, Changzhou
Jiangsu, China
P: +86 519 8919 2555
F: +86 519 8919 1053
E: chinasales@lumascape.com

NORTH AMERICA

1940 Diamond Street, San Carlos
California, 94070 United states
P: +1 650 595 5862
F: +1 650 595 5820
E: info@lumascape.com

MIDDLE EAST, NORTH AFRICA, INDIA, TURKEY

Dubai World Central
Building Block C, Office #432
Dubai, United Arab Emirates
P: +97 4887 9951 or +97 1 54300 0421
F: +971 4887 9601
E: sales@lumascapeme.ae

FOLLOW US

www.lumascape.com