



The Erden Brass EB3 is a robust and compact in-ground luminaire, delivering an impressive output of over 1,400 lumens. IP68 factory-sealed, and featuring a die-cast brass body, it is designed for reliability and superior outdoor performance in the most challenging of environments.

Highly versatile, the Erden Brass EB3 offers two orientations (vertical and a 15° tilted), a selection of stainless-steel and brass lids, glare control louvers, and the choice between direct burial or a pre-installation sleeve for mounting in concrete. This luminaire can also be rotated 360° within its pre-installation sleeve for easy aiming without the need for disassembly or unsealing.

Available in static white or RGBW (with royal blue) and in a range of symmetrical and elliptical beam options. Ideal for a variety of projects, the Erden Brass EB3 is the perfect blend of durability, performance, and style for any outdoor applications.

Performance

Static White & Color <sup>1</sup>	Lumen Output (lm)	Efficacy (lm/W)	Peak Intensity (cd)
3,000 K (80 CRI)	1,320	91	23,800
4,000 K (80 CRI)	1,420	99	25,800

<sup>1</sup> Lumen output values are based on a 15 W luminaire with 10° lens in a vertical orientation

Dynamic Color <sup>2</sup>	Lumen Output (lm)	Efficacy (lm/W)	Peak Intensity (cd)
RGBW (4,000 K) with Royal Blue	890	60	14,300

<sup>2</sup> Lumen output values are based on a 15 W luminaire with 10° lens in a vertical orientation

Beam Angles	Vertical	10°, 13°, 20°, 33°, 47°, 10° x 40°, 40° x 10°, 20° x 66°, 66° x 20°
	Angled	12°, 20°, 36°, 47°, 20° x 40°, 40° x 20°, 25° x 60°, 60° x 25°



Products and specifications are subject to change without notice. DS\_LS3330-241206

### Electrical

<b>Power Consumption</b>	< 15 W
<b>Lifetime</b>	> 179,506 hours @ 122°F (50°C) Ambient Temperature (B10, L90, TM21 Projected)
<b>Input Voltage</b>	Low Voltage                      30 to 48 Vdc
<b>Thermal Management</b>	CoolDrive™ onboard thermal monitoring and control

### Control

<b>Interface</b>	Lumascap <b>PowerSync™</b>
<b>Protocols</b>	DMX/RDM, Artnet <sup>1</sup> , 0-10 V (sink or source) <sup>2</sup>
<b>PWM Frequency</b>	2 kHz flicker-free dimming to 0.1%
<b>RDM Functionality</b>	PowerSync enabled Lumascap luminaires are shipped with a default RDM personality which provides smooth dimming control. For different dimming characteristics or to enable other special functionalities, the default personality can be changed through industry standard DMX/RDM.
<b>Systems</b>	Range of third-party controllers

<sup>1</sup> Some protocols require additional hardware. For more information and other available protocols contact Lumascap.

<sup>2</sup> Not available for color-changing or tunable white

### Physical

<b>Housing</b>	Die-cast brass body with optional stainless-steel or brass lid
<b>Installation</b>	Pre-Installation blockout for concrete pour, drive-over and general use applications. Direct burial for landscapes, planters and special applications.
<b>Adjustability</b>	
<b>Wiring</b>	84 (flexible cable), 82 (½" NPT) Direct Burial and Pre-Install
<b>Ambient Operating Temperature</b>	-4°F to 122°F (-20°C to 50°C)
<b>Surface Temperature</b>	< 149°F (< 65°C)
<b>Weight</b>	6.2 lb (2.8 kg)
<b>Drive-Over</b>	With OptiClear lens and pre-installation kit (LS6387)

### Certification & Compliance

<b>IP Rating</b>	IP68
<b>IK Rating</b>	IK8
<b>Static Load Rating</b>	2,866 lb (1,300 kg)
<b>Environment</b>	Dry, Damp, Wet Locations Inherently protected Suitable for use in poured concrete
<b>Certifications</b>	ETL, CE, RCM, FCC

Dimensions

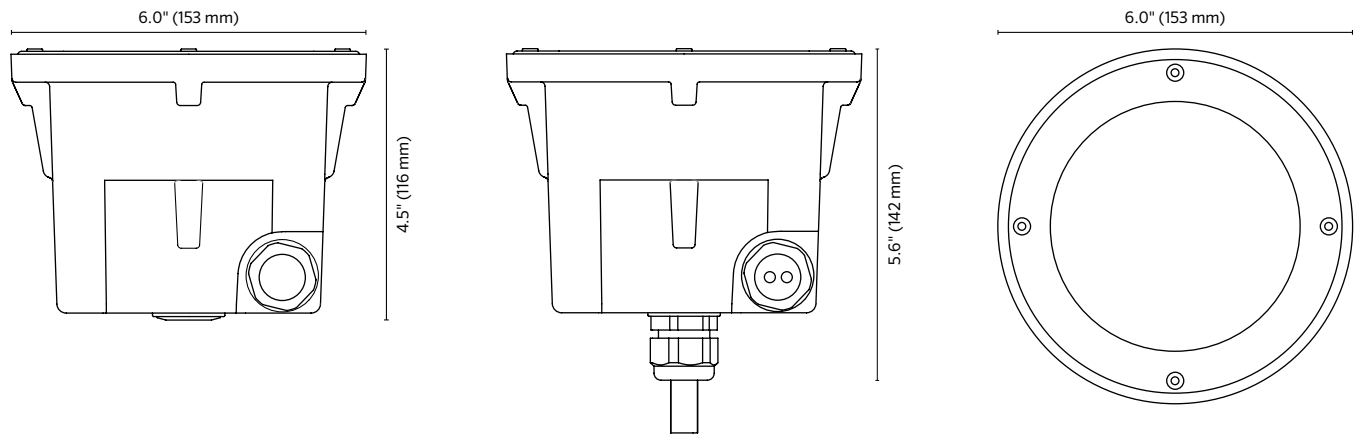

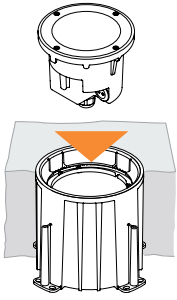

**Pre-Installation Blockout**

This type of installation requires the LS6387 Pre-Installation Kit (ordered separately), which acts as a concrete blockout and is intended for installation before the luminaire. This method ensures the luminaire itself is not damaged during concreting or other site works.

Used for	Drive over applications General use applications Concrete pour applications where luminaire is to be installed after site work has been completed.
Benefits	Easy removal for servicing
Accessories	LS6387 Pre-Installation Blockout

**Connection type '84'**

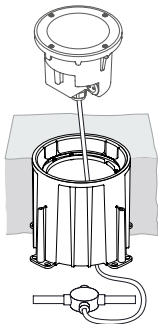

**Flexible Cable**

For connections to the branch circuit via junction box (by others) or other approved method. 6.5' (2 m) length. For other length options, contact Lumascape.

**Connection type '82'**  
North American market only

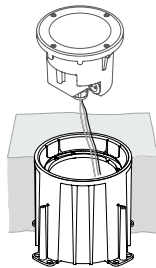

**1/2" NPT Adapter**

The luminaire is factory-fitted with 6.5' (2 m) hookup wire. Ensure terminations can be made within this length. For other length options, consult Lumascape.

**Flush Cover Option**

Flush covers for pre-installation, use special seals and support bushes to ensure static loads up to 2,866 lb (1,300 kg) are properly supported. In order, to achieve this drive-over rating, OptiClear™ or GripGlass™ must be used.



**Pre-Installation Blockout Round Flush Cover**

■ SS316: Polished

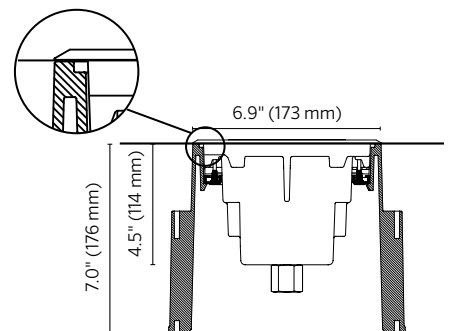

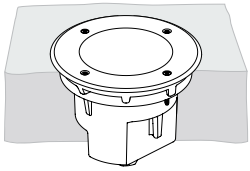

**Direct Burial**

Luminaire is put directly into soil or concrete.

<b>Used for</b>	Landscaping areas Applications where depth is restricted Rate for use in concrete pour applications Economical option
<b>Benefits</b>	Allows for maximum heat dissipation
<b>Restrictions</b>	Not as easy to remove for service as pre-install version Not suitable for drive-over (requires pre-installation) Connection Type 82 only available for North American market.

**Connection type '84'**

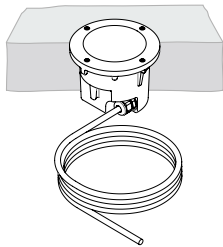

**Flexible Cable**

For connections to the branch circuit via junction box (by others) or other approved method. 6.5' (2 m) length. For other length options, contact Lumascape.

**Connection type '82'**  
North American Market only

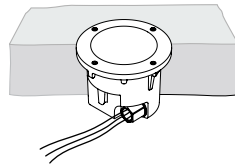

**1/2" NPT Adapter**

The luminaire is factory-fitted with 6.5' (2 m) hookup wire. Ensure terminations can be made within this length. For other length options, contact Lumascape.

**Recessed Cover Options**

Use recessed cover for installation in soil, grass, pavers and other uneven surfaces where no cover overhang is required.



**Round Recessed Cover**  
■ SS316: Polished

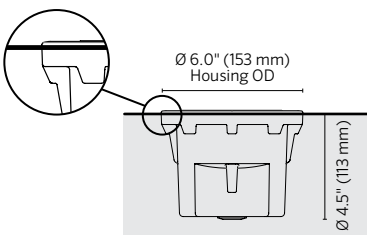

**Round Flush Cover**  
■ SS316: Polished

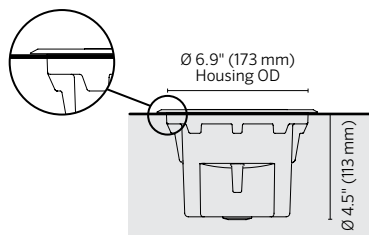

**Integrated Cover Option**

Similar to the recessed cover but features a thick brass trim for a clean edge appearance. It is also ideal for installation in soil, grass, pavers, and other uneven surfaces where no cover overhang is needed.



**Integrated Flush**  
■ Brass

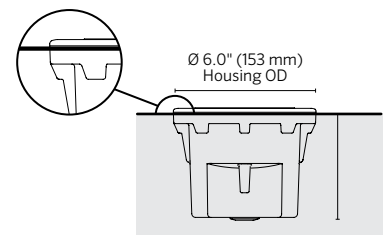



Direct Burial Specification Matrix

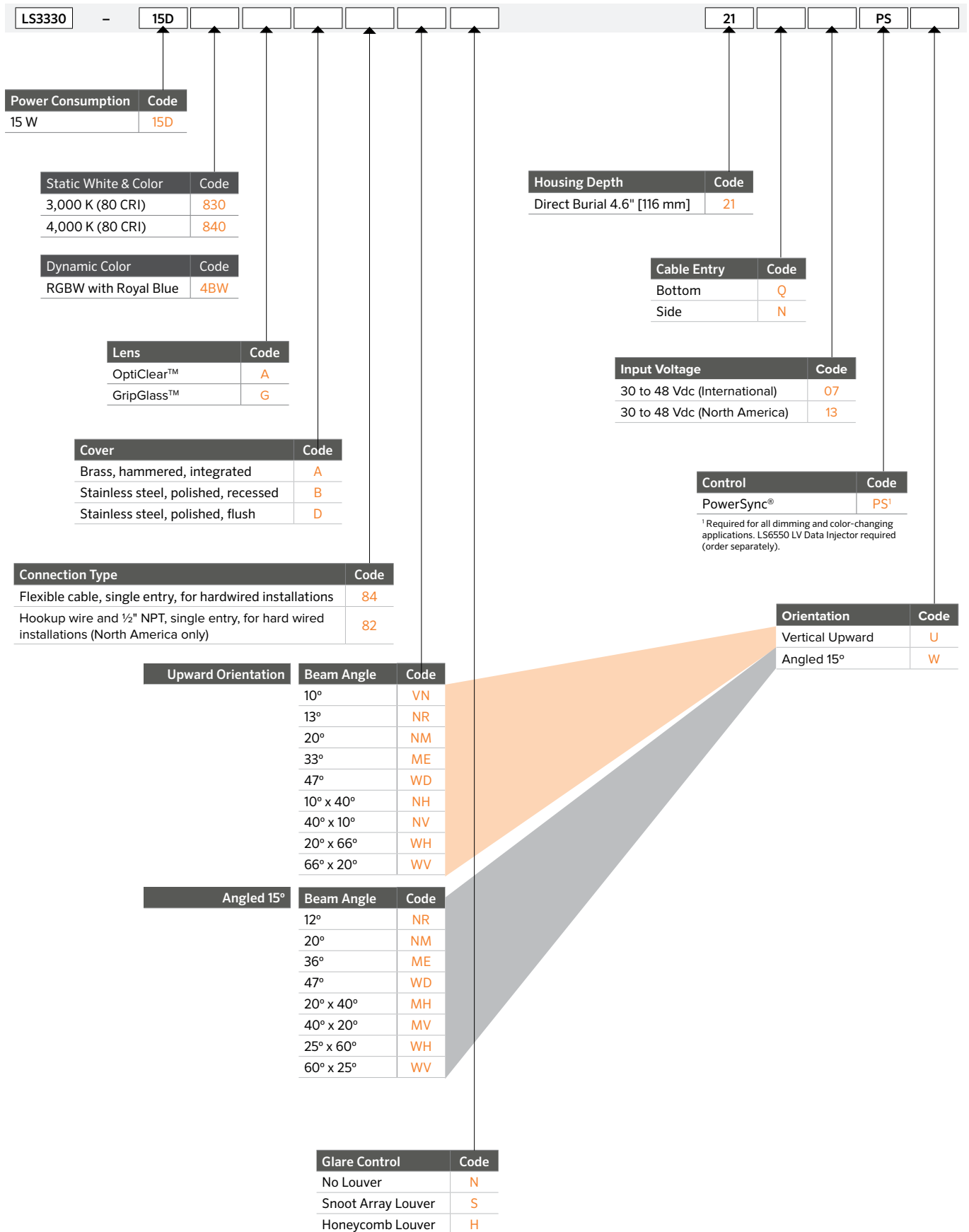

Trunk Topology – Recommended for Above Water Applications

Circuit Limits – Dimmable and Color-Changing via PowerSync™

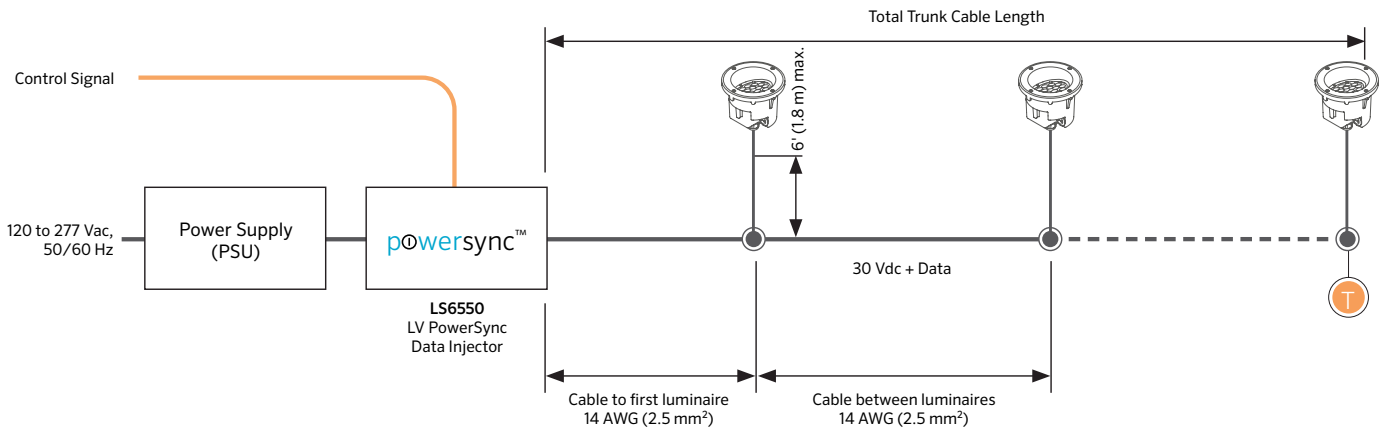

- Refer to "Transformer Compatability Table", for maximum number of luminaires
- Calculations based on 14 AWG (2.5 mm²) trunk cable, and 16' (5 m) trunk cable between luminaires.
- Always observe local electrical codes for branch circuit current limitations
- For other configurations, contact Lumascape.

Transformer Compatability Table

Supply Voltage	Luminaire Power	Max. Leader Cable Length from Power Supply to First Luminaire	Maximum Number of Luminaires per Power Supply		
			120 W	240 W	320 W
30 Vdc	15 W	50' (15 m)	6	8	8
		98' (30 m)	6	7	7
		164' (50 m)	5	5	5
48 Vdc	15 W	50' (15 m)	6	12	16
		98' (30 m)	6	12	15
		164' (50 m)	6	12	15



Terminator

Use PowerSync™ terminator, supplied with PowerSync Injector to terminate last luminaire in chain.

Accessories

PowerSync Low Voltage 30-48 Vdc Data Injector

Translates control signals into a digital format, delivering integral power and data to intelligent LED luminaires. This allows highly-granular addressing and high-speed digital control of every luminaire, using only three wires. The data injector is DIN rail mountable designed to be installed in a switchboard, next to the power supply and circuit breaker that is supplying power to the controlled lighting circuit. Accepts a growing list of standard protocols (0-10 V, DMX/RDM) for simple integration with a wide selection of control systems using these industry standard protocols.



Note:

PowerSync Data Injector ships with three (3) hardwired terminators and one (1) hardwired DMX terminator.

LS6550	
Product	Code
LV Data Injector PS4	LS6550

Luminaire Wire Colors & Designations

Low Voltage 30 Vdc + PowerSync™

Designation	Color
Positive	Red
Negative	Black
Data	Orange

